

Operating instructions

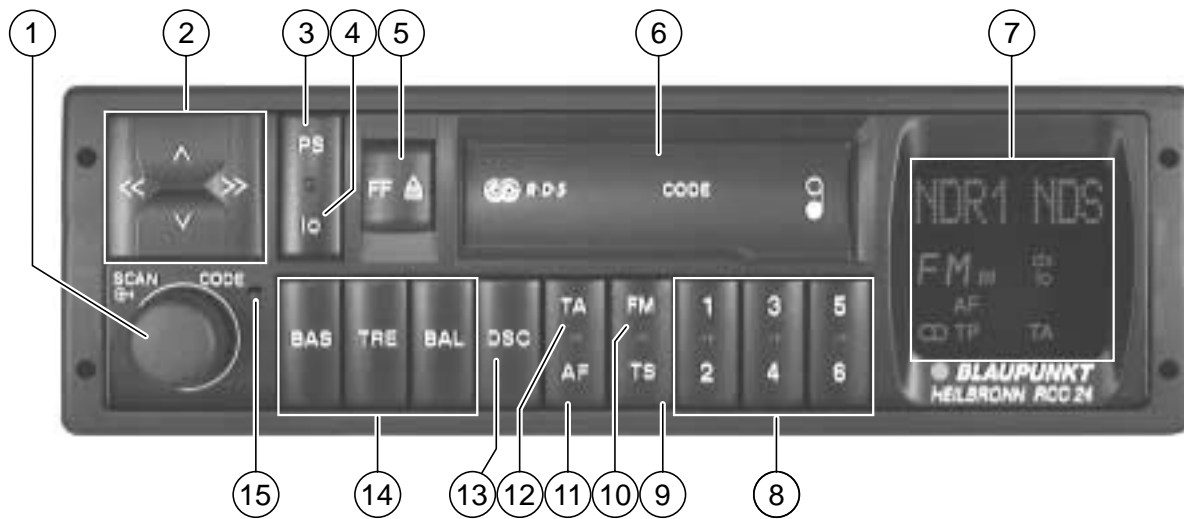

Heilbronn RCC 24



Contents

Short description	15	Radio operation with RDS	19	Tape operation	23
Important information	17	AF - Alternative Frequency	19	Inserting a tape	23
What you need to know!	17	REG - Regional	19	Care of your audio equipment	23
Traffic safety	17	Selecting a station	19	DSC programming	23
Installation/connection	17	Automatic seek tuning	19	Survey of DSC default settings	24
Anti-theft coding	17	Manual seek tuning	19	Appendix	24
Wrong code number entered	17	Adjusting the seek tuning sensitivity	20	Technical data	24
Switching the code system on	18	Stereo - mono switch (FM)	20		
Restart following interruption of power supply	18	Changing the memory bank (FM)	20		
Switching the code system off	18	Storing stations	20		
Optical indication of theft protection	18	Storing the strongest stations auto- matically with Travelstore	20		
		Recalling stored stations	21		
		Sampling stored stations briefly with Preset Scan	21		
		Sampling stations briefly with Radio Scan	21		
		Reception of traffic announce- ments with RDS-EON	22		
		Priority of traffic announcements ON/OFF	22		
		Warning beep	22		
		Switching the warning beep off	22		
		Automatic seek tuning start	22		
		Adjusting the volume for traffic messages and warning beep	22		

Short description

① Amplifier

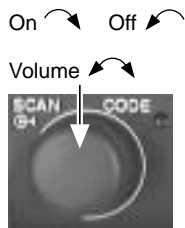

When “CODE” lights up in the display, read chapter “Anti-theft coding” first.

SCAN

Hold down for approximately 1 second to sample all stations to be received.

② Rocker switch

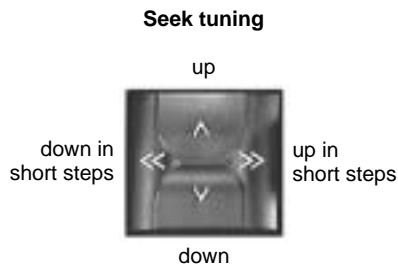

Extra functions:

Coding: Enter code and confirm with ▲.

DSC mode: Select and program DSC settings.

③ PS (Preset Scan)

To briefly sample all stored stations of the selected memory bank (FM I-III or T).

④ lo

Seek tuning sensitivity

lo lit up in the display indicates normal seek tuning sensitivity (the system will pick up strong stations only).

dx lit up in the display indicates high seek tuning sensitivity (the system will also pick up weaker stations).

To change the seek tuning sensitivity: press lo.

⑤ FF ▲

FF – Fast Forward

Start/stop: Press button briefly

▲ Press button to eject the tape.

⑥ Cassette slot

Insert tape (side A or 1 facing up, the open side facing to the right).

7 Display

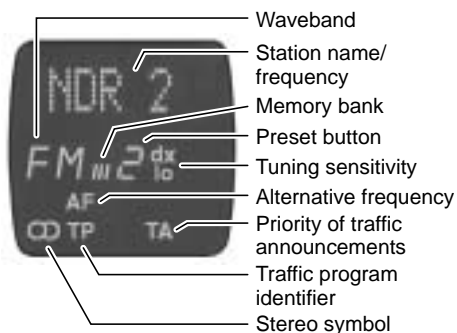

8 1, 2, 3, 4, 5, 6 - preset buttons

You can store 6 stations on each FM memory bank (I, II, III and T).

To store a station: Press button during radio operation and hold it down until the radio resumes play.

To recall a station: Select a memory bank (press repeatedly if necessary and then press the required preset button).

Extra function:

Coding - Read chapter “Anti-theft coding” first.

Buttons **1, 2, 3, 4** - To enter the four-digit code.

9 TS (Travelstore)

To store the six most powerful nearby stations automatically with Travelstore:
Store: Press TS until seek tuning starts (see display).

Recall: Press TS. Then briefly press one of the presets **1, 2, 3, 4, 5, 6**.

10 FM

To select one of the FM memory banks I, II or III.

To change the memory bank:

Press button until the desired memory bank is indicated in the display.

11 AF button (Alternative Frequency)

RDS mode

If AF is on, the radio will automatically switch to the strongest frequency of the same program.

“AF” on/off: Press **AF** button briefly.

12 TA (Traffic Announcement)

If TA is on, only traffic announcements will be received.

TA on/off: press button.

13 DSC (Direct Software Control)

Use the DSC function to change a number of basic settings. See “DSC programming” for more details.

14 BAS - Bass

TRE - Treble

BAL - Balance (left/right)

To select, press TRE, BAS or BAL.

The set value is shown in the display (e.g. TRE +5).

Then use the rocker switch ② to change the value. Press any other button to store the new value.

If the value is not changed within 8 seconds, the display will show the previous setting again.

15 Security LED (CODE-LED)

Flashes as additional anti-theft protection when the car radio is turned off, provided you have activated this mode before under DSC - CODE-LED.

Important information

What you need to know!

Before starting to use your new car radio you should carefully read through the information on "Traffic safety" and "Anti-theft coding".

Traffic safety

Traffic safety has always priority. Use your car radio in such a manner that you are always able to cope with and react to the prevailing traffic situation at any given time. Remember, even at 50 km/h you are still moving at a speed of 14 m per seconds.

It is also very important that you are able to hear, and react to, acoustic warning signals around you, for example from the police or the firebrigade.

Therefore, adjust the volume reasonably.

Installation/connection

The code system can only be switched on and off, if the radio is connected to permanent power.

If you like to install your new car radio by yourself or add other audio components to the existing ones, then please read carefully the enclosed instructions on installation and connection.

Do not connect the loudspeaker outputs to ground!

Only use the accessory and replacement parts approved by Blaupunkt.

Anti-theft coding

The car radio comes standard with the code system deactivated.

If the anti-theft coding system is on while the power supply to the unit is interrupted (e.g. theft, disconnecting the car battery), the set is electronically blocked. Then it may only be used again after the appropriate code number has been entered (see car radio passport).

Wrong code number entered

It should not be possible for thieves to ascertain the code number by trial-and-error. This is why the set will be blocked for a certain period of time, if an incorrect code number is entered. In this case, "- - -" will appear in the display.

This waiting time is 10 seconds after the first three attempts, and 1 hour following subsequent attempts.

After 19 unsuccessful attempts, "OFF" will appear in the display and the set can no longer be restarted.

Note:

Keep your car radio passport with the code number in a safe place in order to avoid "unauthorized access" to your car radio.

If the power supply to the radio is interrupted while the code system is switched on, you need to know the right code number.

The radio will operate again as soon as you have entered the right code number.

If you lose your radio passport and have forgotten your code number, you will not be able to restart the set after the power supply has been interrupted. In this case, your radio can only be reset in our central customer service workshop or in one of our service agencies abroad.

Switching the code system on

Precondition:

The radio must be connected to permanent power.

In order to switch the code system on:

- Turn the radio off.
- Hold down the preset buttons **1** and **4** simultaneously.
- Turn the radio on.
“CODE” briefly appears before the radio begins to operate.
- Release preset buttons **1** and **4**.

The code system is on.

“CODE” will be briefly displayed each time the radio is turned on.

Restart following interruption of power supply (Code system switched on)

- Switch on the set.
“CODE” will appear in the display.
- Briefly press preset button **1**, “0000” will appear in the display.
- Enter the code number given in the Blaupunkt car radio passport:
Example: the code number is 2521.
 - Press preset button **1** twice, “2000” appears in the display.
 - Press preset button **2** five times, “2500” appears in the display.
 - Press preset button **3** twice, “2520” appears in the display.
 - Press preset button **4** once, “2521” appears in the display.
- To confirm the code number:
Press the upper part of the rocker switch \wedge .

Your car radio is now ready for operation.

If four dashes appear again in the display, you have entered a wrong code number. Now it is essential to enter the correct code after the waiting period has elapsed (CODE in the display).

If the radio is turned off before the waiting period has elapsed, then the waiting period restarts as soon as the radio is turned on again.

Switching the code system off

- Turn off the radio.
- Simultaneously press preset buttons **1** and **4** and hold them down.
- Turn the set on.
“CODE” will appear in the display.
- Enter the code number given in the Blaupunkt car radio passport and confirm: See example “Restart following interruption ...”.

The code system is now deactivated.

Optical indication of theft protection

When the car is stationary, an optical security system in the form of a flashing LED can be activated to visualize that your radio is code-protected.

Depending on how you have hooked up your radio, three different LED modes are available, which can be programmed with the DSC function.

See “DSC programming” for more details.

Radio operation with RDS

An ever increasing number of FM radio stations broadcast additional information in parallel to their normal program via the Radio Data System to make reception even more convenient.

As soon as radio programs can be identified, the station name and possibly the regional identifier are in the display, e.g. NDR1 NDS (local radio program in Lower Saxony, Germany).

With RDS, the preset buttons turn into program buttons. Now you know exactly to which program your set is tuned in and thus you can choose precisely the desired program. RDS offers further advantages:

AF - Alternative Frequency

The AF function assures that the strongest frequency of the selected program is tuned in automatically.

This function is on, if the display shows "AF". To switch AF on/off,

- press **AF** briefly.

During seek tuning to the strongest frequency, the radio operation is muted for a moment. If "SEARCH" appears in the display when turning the set on or when calling up a stored frequency, the set is automatically searching for an alternative frequency.

"SEARCH" goes out as soon as the system has found an alternative frequency or after the frequency band has been scanned completely.

Should the reception quality of the selected program become too bad,

- tune into another program.

REG - Regional

The AF function can also be used to activate and deactivate the regional function. At some time of the day, larger radio stations split up their main program into regional program versions offering local information.

If you want the radio to lock onto a regional program,

- hold down the **AF** button for about 2 seconds.

The display will show "REG ON".

If you leave the service area of the regional program or if you wish to use the entire RDS service, switch to "REG OFF".

- Hold down the **AF** button for about 2 seconds until "REG OFF" is displayed.

If "REG ON" is activated, the display will show "REG ON" each time the radio is switched on.

Selecting a station

FM radio stations in the range between 87.5 and 108 MHz can be received.

Automatic seek tuning \wedge/\vee

- Press \wedge/\vee . The radio will automatically tune to the following station.

If you press the upper or lower part of the rocker switch (\wedge/\vee), seek tuning speeds up in forward and backward direction.

Seek tuning

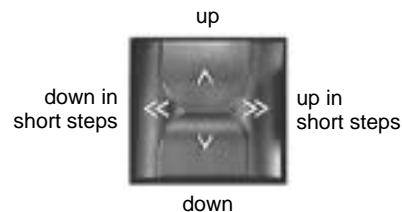

Manual seek tuning << >>

- Press << or >> to change the frequency in small steps in either direction.

Hold down the right or left part of the rocker switch to speed up this process.

Adjusting the seek tuning sensitivity

Two basic levels can be selected for the seek tuning sensitivity.

If **lo** is displayed, the radio will only tune to strong stations (low sensitivity).

If **dx** is displayed, you will also receive less powerful stations (higher sensitivity).

To change the seek tuning sensitivity,

- press **lo**.

The two basic sensitivity levels can be further varied (see “DSC programming”).

Stereo - mono switch (FM)

You can switch to mono when the reception quality becomes poor:

- Press **lo** for approximately 2 seconds. During mono reception the stereo symbol  will go out in the display.

Each time the car radio is switched on, the radio will automatically be set to stereo reception.

It will automatically shift to mono when the reception quality becomes poor.

Changing the memory bank (FM)

You can shift between the memory banks I, II and III to store and recall preset stations.

The selected memory bank is indicated in the display.

- Press **FM** until the desired memory bank lights up in the display (press repeatedly if necessary).

Storing stations

On each FM memory bank (I, II, III and TS) you can store six stations on the preset buttons **1, 2, 3, 4, 5, 6**.

- Select the memory bank by pressing **FM** or **TS** to adjust the waveband. Press the **FM** button to select one of the FM memory banks.
- Use the rocker switch to tune to a station (either automatically or manually).
- Press the desired preset button and hold it down. The radio will be muted and resumes play after about 2 seconds.

Now the station is stored.

The activated preset button is indicated in the display.

Note:

If you tune to a station which is already stored, the corresponding preset button and the memory bank will flash in the display for approximately 5 seconds.

Storing the strongest stations automatically with Travelstore

You can use the Travelstore memory bank to automatically store the six strongest FM stations sorted on the preset buttons according to their signal strength. This feature is especially useful when travelling, because it will always give you the most powerful stations at a fingertip as you pass through the various reception areas.

- Press **TS** for at least 2 seconds.

The radio will seek for the most powerful nearby FM stations and store them on the memory bank “T” (Travelstore). Once the process is completed, the station allocated to preset button 1 will be played.

FM stations can also be stored manually on the Travelstore bank (see “Storing stations”).

Recalling stored stations

You can recall any stored station by pressing the corresponding preset button.

- Use the **FM** or **TS** button to select the desired memory bank.
For this purpose, press **FM** until the desired memory bank is indicated in the display.
- Briefly press the desired preset button.

Sampling stored stations briefly with Preset Scan

You can briefly sample all preset stations of the FM or TS memory bank using the Preset Scan function.

- Press **FM** or **TS**.
- Press **PS**.
The set will sample all stations of the selected memory bank.

Free preset buttons will be skipped.

To stop this function:

- Press **PS** once again.
The radio will continue to play the currently sampled station.

Sampling stations briefly with Radio Scan

This function allow you to sample the subsequent stations briefly for approximately 8 seconds each.

To active Scan:

- press button ① for approximately 1 second.
Then sampled frequency or the station logo starts flashing in the display. During the actual searching process, "SCAN" is flashing.

To select a sampled station/switch Scan off:

- press button ① briefly.

If no station is selected during the scan operation, the radio returns to the station where Scan has been started before.

Reception of traffic announcements with RDS-EON

Many FM broadcasters provide their service area with up-to-date traffic messages at regular intervals.

All traffic program stations transmit a special signal in parallel to the radio program. Your car radio is able to identify such traffic program station by this TP signal. The display will indicate “**TP**” to confirm that a traffic program station is tuned in.

If you press TA when a traffic announcement is played, the radio stops playing the message and switches to the previous mode. The priority of later traffic announcements remains on.

Other radio stations do not air traffic announcements by themselves, but offer the possibility to receive the traffic announcements of another radio station within the same radio network. In this case, **TP** also lights up in the display.

TA is displayed, if the priority of traffic announcements is on.

If a traffic announcement is aired, your radio will switch to the traffic program station for the duration of the message and will switch back to the previous station after the end of the message.

Priority of traffic announcements ON/OFF

“**TA**” lights up in the display, if the priority of traffic announcements is on. To switch the function on and off,

- press the **TA** button.

Warning beep

Whenever you leave the reception area of the traffic program station you are tuned to, you will hear a warning beep after approximately 30 seconds.

This warning beep will also be released, if you press a preset button to recall a preset station without traffic program.

Switching the warning beep off

a) Tune to another traffic program station:

- Press the rocker switch  or
- press a preset button to recall a traffic program station.

or

b) Switch the traffic message priority off:

- Press **TA**.
“**TA**” goes out in the display.

Automatic seek tuning start (During cassette operation)

If you leave the reception area of your traffic program station while you are playing a cassette, the car radio will automatically tune into another traffic program station.

If no traffic program station is found within approximately 30 seconds, the tape will be stopped and you will hear a warning beep.

To switch the warning beep off, proceed as detailed above.

Adjusting the volume for traffic messages and warning beep

A default value is set ex factory for the volume of traffic announcements and the warning beep. You can change this default setting with the DSC function (see “DSC programming, ARI (TA)”).

Tape operation

Inserting a tape

- Turn the set on.
- Insert a tape.

Fast Forward

Start/stop:

Press button briefly

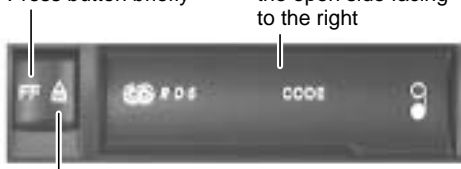

Press button firmly
to eject the tape

Insert **tape** with
side A or 1 **facing up**,
the open side facing
to the right

When listening to a tape, the display shows "TAPE".

As soon as the end of the tape is reached, the system switches to radio operation.

Care of your audio equipment

We recommend you to use C-60/C-90 tapes only in your car stereo. Protect your tapes by storing them away from dirt and dust and do not expose them to excessive temperatures (above 50°C). In order to ensure smooth tape operation, cold tapes should be warmed up before they are played. If dust collects on the rubber roller or on the audio head, problems may arise which affect tape operation or sound quality after approximately 100 hours of operation.

Normally it is sufficient to use a head cleaning cassette to clean your tape player; for tougher cases use a cotton swab (Q-tip) soaked with alcohol. Never use rigid tools to clean your unit!

DSC programming

This car radio offers direct software control (DSC) to adjust a number of default settings to your personal needs and store them.

The following step describes all the default settings which can be changed.

To activate the DSC mode,

- press **DSC**.

Use the rocker switch to select and change the following adjustments. The default value is shown in the display.

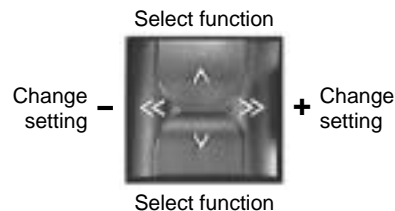

LOCAL (lo)

To adjust the tuning sensitivity for local reception

LOCAL 1 - high sensitivity
LOCAL 3 - low sensitivity

DIS (dx)

To adjust the tuning sensitivity for distant reception

DIS. 1 - high sensitivity
DIS. 3 - low sensitivity

Appendix

LOUD Loudness - To boost low bass frequencies.
LOUD 0 - no boost
LOUD 6 - strong boost

BEEP Acknowledgement tone for function keys to be hold down for more than 2 seconds. Adjust volume between 0 and 9 (0 = OFF).

ARI (TA) To adjust the volume of traffic announcements between 1 and 9.

To quit DSC programming and to store the setting,

- press **DSC**.

Survey of DSC default settings

LOCAL : 1
DIS : 1
LOUD : 5
BEEP : 5
ARI : 5

Technical data

Amplifier:

Output power: 2 x 10 W RMS power according to DIN 45324/3.1 into 4 Ω

FM:

Sensitivity: 1.0 μ V at 26 dB signal-to-noise ratio

Frequency response: 35 - 15 000 Hz (-3 dB)

Cassette:

Frequency response: 40 - 14 000 Hz (-3 dB)

Subject to modifications!

Blaupunkt-Werke GmbH
Bosch Gruppe

K7/VKD 3 D94 162 017